

Escape Sign Luminaire

GuideLed CG-S Ceiling Mounting

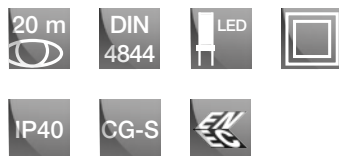

- Escape sign panel luminaire in LED technology for ceiling installation.
- Slender design with pictogram width of only 12 mm
- Very good perceptibility on account of high luminance of the white contrasting colour > 500 cd/m² in keeping with standard ISO 3864-1 and high uniformity $L_{\min}/L_{\max} > 0.8$
- Increased safety by use of 3-chip LEDs.
- Reduced battery costs on account of especially low power consumption.
- Low operating costs on account of low effective power of 2.9 W only (1.9 W one-sided)
- Minimum service requirement due to high service life of the LEDs (50 000 hours).



GuideLed 10021 CG-S



GuideLed 10022 CG-S



GuideLed 10024 CG-S

Viewing distance:	20 m
Luminous flux Φ_e/Φ_N at the end of rated operating time	100 %
Housing material	PC, PMMA
Housing colour	Light grey RAL 7035
Weight	0.39 kg (10021 LED CG-S) 0.49 kg (10022 LED CG-S) 0.54 kg (10023 LED CG-S) 0.70 kg (10024 LED CG-S)
Type of mounting	Ceiling, suspended, recessed installation
Connection terminal	Clamp terminal 2.5 mm ² reverse-polarity protected
Connection voltage	220 - 240 V AC, 50/60 Hz 176 V - 275 V DC
Current consumption - battery operation (220 V)	one-sided 8 mA – two-sided 12 mA
Power consumption mains operation (apparent power / effective power)	one-sided 4.0 VA / 1.9 W two-sided 5.5 VA / 2.9 W
Permissible ambient temperature	-20 °C to +40 °C
Light source	LED batten with 3-chip LEDs

Ordering details - fastening set

Scope of supply	Order No.
Ceiling installation set for GuideLed 10021 CG-S with canopy incl. LED supply and CG-S technology (20 addresses)	40071353610
Ceiling installation set for GuideLed 10022 CG-S with canopy and tube suspension 0.5 m incl. LED supply and CG-S technology (20 addresses)	40071353611
Ceiling installation set for GuideLed 10023 CG-S with canopy and tube suspension 1.5 m incl. LED supply and CG-S technology (20 addresses)	40071353612
Ceiling installation set for GuideLed 10024 CG-S incl. recessed installation housing incl. LED supply and CG-S technology (20 addresses)*	40071353613

Ordering details - accessories

Scope of supply	Order No.
Chain fastening for 10021 CG-S	40071353645
Concrete installation GuideLed 10024 CG-S, 20 m*	40071352892

* Ceiling mounting set for GuideLed 10024 and concrete installation box corresponding to protection class I

Escape Sign Luminaire GuideLed CG-S Ceiling Mounting

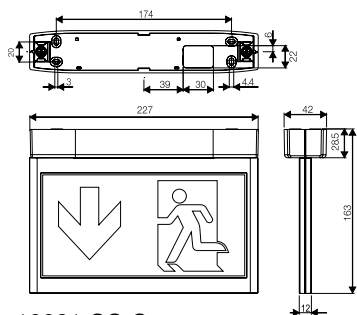

10021 CG-S

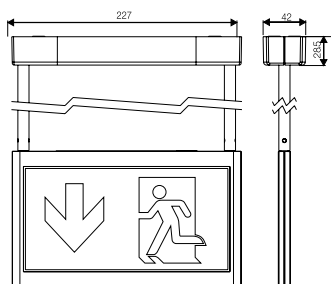



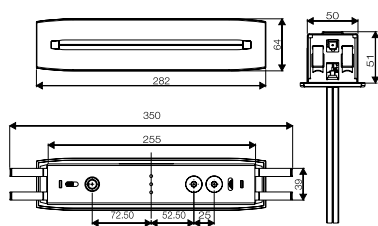











10022 / 10023 CG-S



10024 CG-S

Ordering details - LED pictograms*

Scope of supply		Order No.
LED pictogram PL/PR, for GuideLed 10021/10022/10023/10024 CG-S, ISO 7010, 20 m	 	40071354503
LED pictogram PU/PU, for GuideLed 10021/10022/10023/10024 CG-S, ISO 7010, 20 m	 	40071354504
LED pictogram PL/BL, for GuideLed 10021/10022/10023/10024 CG-S, ISO 7010, 20 m	 	40071354505
LED pictogram PR/BL, for GuideLed 10021/10022/10023/10024 CG-S, ISO 7010, 20 m	 	40071354506
LED pictogram PU/BL, for GuideLed 10021/10022/10023/10024 CG-S, ISO 7010, 20 m	 	40071354507
LED pictogram PL/PR-R**, for GuideLed 10021/10022/10023/10024 CG-S, ISO 7010, 20 m	 	40071354508
LED pictogram PL/PR-W**, for GuideLed 10021/10022/10023/10024 CG-S, ISO 7010, 20 m	 	40071354509

* Fastening set required

** R = Arrow from mounting wall
W = Arrow to mounting wall